

**SQUARE D COMPANY**  
**CIRCUIT BREAKERS**

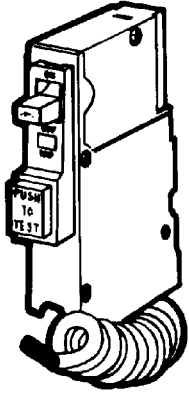

**CRV#116930** BREAKER, GFI 20A SQ 'D'  
( QO-120-GFI )

**CRV#116931** BREAKER, GFI 30A SQ 'D' - NLA  
( QO-130-GFI )

**CRV#124550** BREAKER, GFI 15A SQ 'D' - NLA  
( QO-115-GFI )

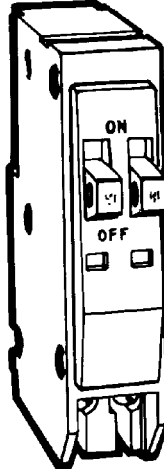

15/15 AMP. CSA  
15/20 AMP.  
20/30 AMP. CSA

DOUBLE CIRCUIT BREAKERS

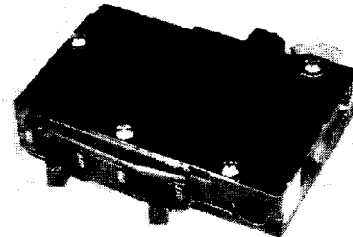

QO TANDEM CIRCUIT  
BREAKER  
2 - SINGLE POLES  
1 SPACE

#QOT1515  
#QOT1520  
#QOT3020

**CRV# 110116 - NLA**  
**CRV# 111414**  
**NLA**

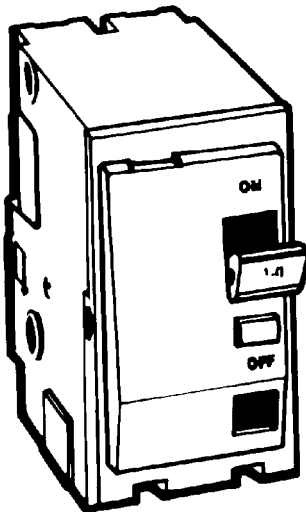

NEUTRAL SWITCH BREAKER  
#QO230SWN **CRV# 112783**

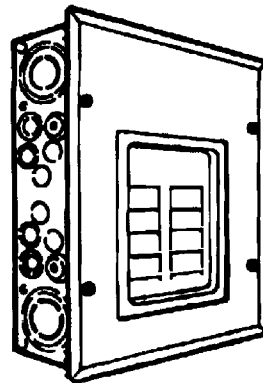

100 AMP. LOAD CENTER  
WESCO #5816CG  
**CRV# 361143 - NLA**

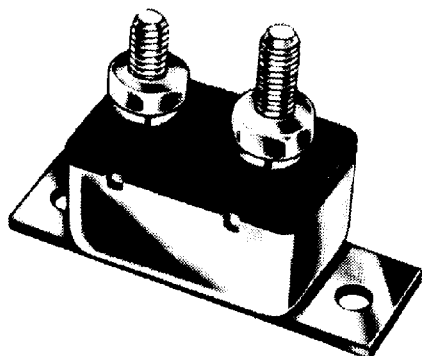

MINI CIRCUIT BREAKER 12-VOLT  
 50 AMP      **CRV# 304267**  
 30 AMP      **CRV #304268**  
 20 AMP      **CRV #304269**  
 15 AMP      **CRV #304270**

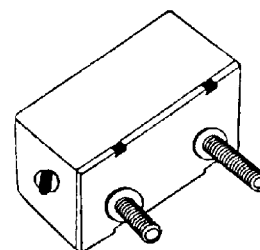

CIRCUIT BREAKER 12-VOLT  
 MANUAL RESET TYPE 3  
 50 AMP      **CRV# 442944**  
 15 AMP      **CRV #442945**  
 30 AMP      **CRV #413544**  
 40 AMP      **CRV #471191**

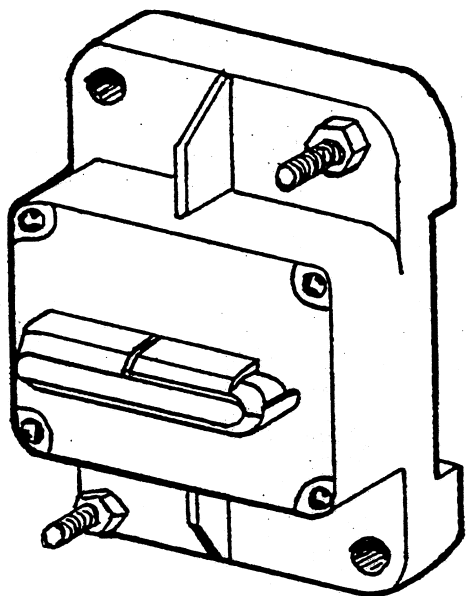

CIRCUIT BREAKER FOR GEN COMP  
 120 AMP      **CRV #380384**